

PTE

Serial/Ethernet Converter & Modbus Gateway

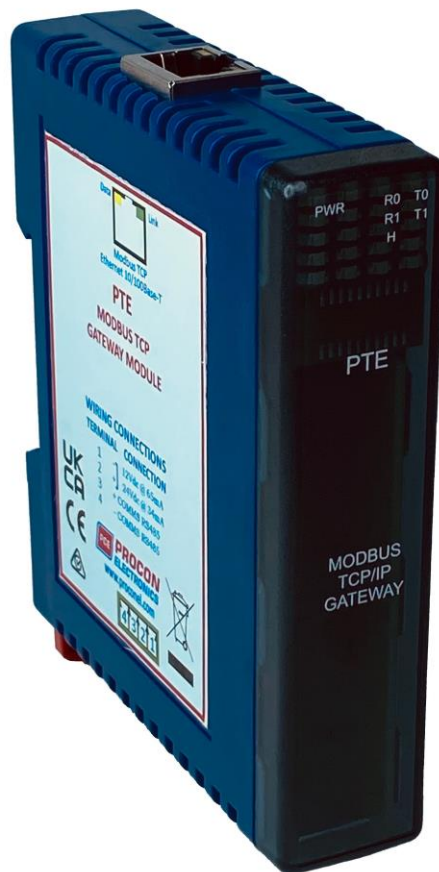

USER GUIDE



22/195 Prospect Highway
Seven Hills 2147
NSW
Australia

Tel: +61 (02) 96248376
Fax: +61 (02) 96208709
Email: proconel@proconel.com
Web: www.proconel.com

Disclaimer

Procon Electronics makes no representations or warranties with respect to the contents hereof. In addition, information contained herein are subject to change without notice. Every precaution has been taken in the preparation of this manual. Nevertheless, Procon Electronics assumes no responsibility, express or implied, for errors or omissions or any damages resulting from the use of the information contained in this publication.

All trademarks belong to their respective owners.

TABLE OF CONTENTS

1. Description	4
2. Operating Modes.....	5
2.1 Mode 0.....	5
2.1.1 Modbus gateway – Using TCP.....	5
2.1.2 Transparent Mode – Using TCP	5
2.1.3 Modbus gateway – Using UDP.....	5
2.1.4 Transparent Mode – Using UDP	5
2.2 Mode 1.....	6
2.2.1 Modbus gateway – Using TCP.....	6
2.2.2 Transparent Mode – Using TCP	6
2.3 Mode 2.....	6
3. Application Example – Mode 0.....	7
4. Physical Dimensions	8
4.1 Grounding/Shielding.....	8
5. Technical Specification	9
6. Configuration	10
6.1 Power Connections.....	10
6.2 Ethernet Connection.....	10
6.3 Indication LED'S.	10
RS485 Termination.	10
6.4 Setting the jumpers for the RS485 Termination (J5).	11
6.5 Connecting To a PC which is not Connected to a Network.	12
6.6 Connecting to a PC which is Connected to a Network.	14
6.7 Testing the Connection.....	14
6.8 Viewing Web Pages	15
6.9 Troubleshooting Guide.....	16
6.10 Parameter Configuration.....	17

1. Description

The PTE Gateway enables serial devices, such as PROMUX modules, communicating on RS485 to be connected to a 10/100 Base-TX Ethernet network.

The PTE Gateway can be configured to operate in a number of different modes depending on the application. It can be configured as a transparent data link or it can perform the gateway function of converting Modbus TCP messages to Modbus RTU messages.

Mode 0: Server with slave device connected to the serial port, multi socket.

Mode 1: Server with slave device connected to the serial port or to be used with a Client Converter for point-to-point, single socket.

Mode 2: Client to be used with a Server Converter for point-to-point, single socket.

The PTE Gateway includes a web server which enables access to internal parameters for configuration. This allows configuration of IP address, serial data format and operating modes. The web server can be accessed by most web browsers.

The PTE Gateway supports the FTP protocol which enables the web pages to be customized if required.

Each PTE Gateway has a unique Ethernet IP address which must be programmed into the PC or PLC. The IP address in the gateway is configured via the Web Server. Any standard Web browser such as Internet Explorer can be used to access the web pages where configuration is carried out. The gateways are factory programmed with a default IP address of 169.254.111.111. This address must be changed before the gateway is added to an existing network.

The web page address for viewing the setup parameters is <http://169.254.111.111/index.htm> The web page address for configuring the gateway is <http://169.254.111.111/ip.htm>

The master device which is polling the modules must be configured with the IP address of the gateway and with the Modbus ID of the Modbus modules. By using more than one PTE gateway, it is possible have multiple RS485 networks on the same ethernet network. Consequently, many hundreds of PROMUX modules may be added to an Ethernet network.

2. Operating Modes

2.1 Mode 0

Mode 0 is the standard server configuration for most PTE Gateway applications. This mode has been designed to service multiple sockets which enables up to 4 masters to communicate with the slaves which are connected to the gateway.

Each socket is serviced in turn, and any message in the socket is sent out on the serial port. The gateway then starts a timer waiting for a reply. When a reply is received the message is put into the initiating socket and send out on the Ethernet network. The gateway then checks the next socket. If no reply is received then the timer expires and the gateway checks the next socket. This timer is configured on the ip.htm web page and is labeled" Serial Reply Timeout".

The gateway can also accept messages on UDP instead of TCP. Operation is the same and does not need any special configuration.

There are a number of different configurations for this mode as follows:

2.1.1 Modbus gateway – Using TCP

When used as a Modbus gateway the client must be configured to use **Port 502**. This is a reserved port number for Modbus TCP applications and informs the gateway that it must implement the protocol conversion from Modbus TCP on the Ethernet network to Modbus RTU on the serial network.

2.1.2 Transparent Mode – Using TCP

When used in transparent mode the client must be configured to use **Port 1234**. This port number informs the gateway that any data that is received in a socket must be transmitted out the serial port without any protocol conversion.

2.1.3 Modbus gateway – Using UDP

When used as a Modbus gateway the client must be configured to use **Port 502**. This is a reserved port number for Modbus TCP applications and informs the gateway that it must implement the protocol conversion from Modbus TCP on the Ethernet network to Modbus RTU on the serial network.

2.1.4 Transparent Mode – Using UDP

When used in transparent mode the client must be configured to use **Port 1234**. This port number informs the gateway that any data that is received in a UDP datagram must be transmitted out the serial port without any protocol conversion.

2.2 Mode 1

Mode 1 is a server configuration and is similar to Mode 0 except that this mode only makes use of a single socket.

This single socket implementation waits for messages to come in on the Ethernet network and sends them out the serial port. Any messages being received on the serial port are sent out on the Ethernet network. As there is only one socket, there is no need for the timer as in mode 0.

There are a number of different configurations for this mode as follows:

2.2.1 Modbus gateway – Using TCP

When used as a Modbus gateway the client must be configured to use **Port 502**. This is a reserved port number for Modbus TCP applications and informs the gateway that it must implement the protocol conversion from Modbus TCP on the Ethernet network to Modbus RTU on the serial network.

2.2.2 Transparent Mode – Using TCP

When used in transparent mode the client must be configured to use a **PORT** number chosen by the user. This port number informs the gateway that any data that is received in a socket must be transmitted out the serial port without any protocol conversion and must not be one of the reserved numbers 21(ftp), 80(http), 502(Modbus). This is the mode that is used to create a transparent **point-to-point** serial-ethernet-serial **link** with a client gateway.

2.3 Mode 2

Mode 2 is a Client configuration and is used to make a transparent link with a server gateway. This mode only makes use of a single socket.

This single socket implementation waits for messages to come in on the Ethernet network and sends them out the serial port. Any messages being received on the serial port are sent out on the Ethernet network. As there is only one socket, there is no need for the timer as in mode 0.

When messages are received on the serial port they are sent out on the Ethernet network. Due to the fact that the Ethernet network is normally faster than the serial data being received, the serial message being received will get broken up into small blocks and then sent on the Ethernet network. This could result in the Ethernet network being flooded with many messages sending one or two characters at a time. To prevent this from happening, a timer is used. This timer starts when the first character is received on the serial port and when it expires any received characters in the serial port buffer are sent out on the Ethernet network. This timer is disabled if a value of 0 is programmed. The timer is labeled “**Char Timeout**” on the ip.htm web page.

The client gateway must be configured to use a **PORT** number chosen by the user. This port number must be the same which is programmed into the server gateway. This Port number informs the converter that any data that is received in a socket must be transmitted out the serial port without any protocol conversion and must not be one of the reserved numbers 21(ftp), 80(http), 502(Modbus). This is the mode that is used to create a transparent **point-to-point** serial-ethernet-serial **link** with a server gateway.

The Client gateway has to open the socket with the Server gateway. In order to do this, the IP address of the Server must be configured in the Client gateway. This is done on the ip.htm web page and is labeled “**Server IP**”.

3. Application Example – Mode 0

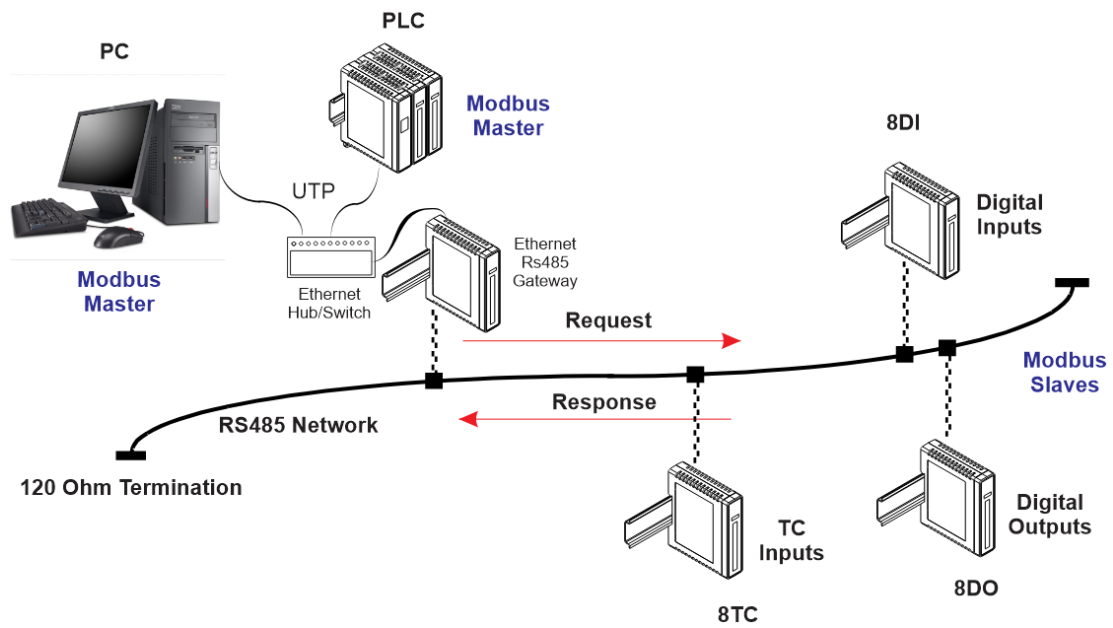

4. Physical Dimensions

The PTE gateway enclosure is shown below. The module clips directly onto an industry standard DIN rail. The module power and RS485 communications wiring is on a separate plug-in connector on the underside of the housing, the Ethernet communications plugs into a RJ45 connector on the top of the housing.

Allow at least 25mm below and above the module to accommodate the wiring. Ensure that enough space is kept above and below the module for good ventilation.

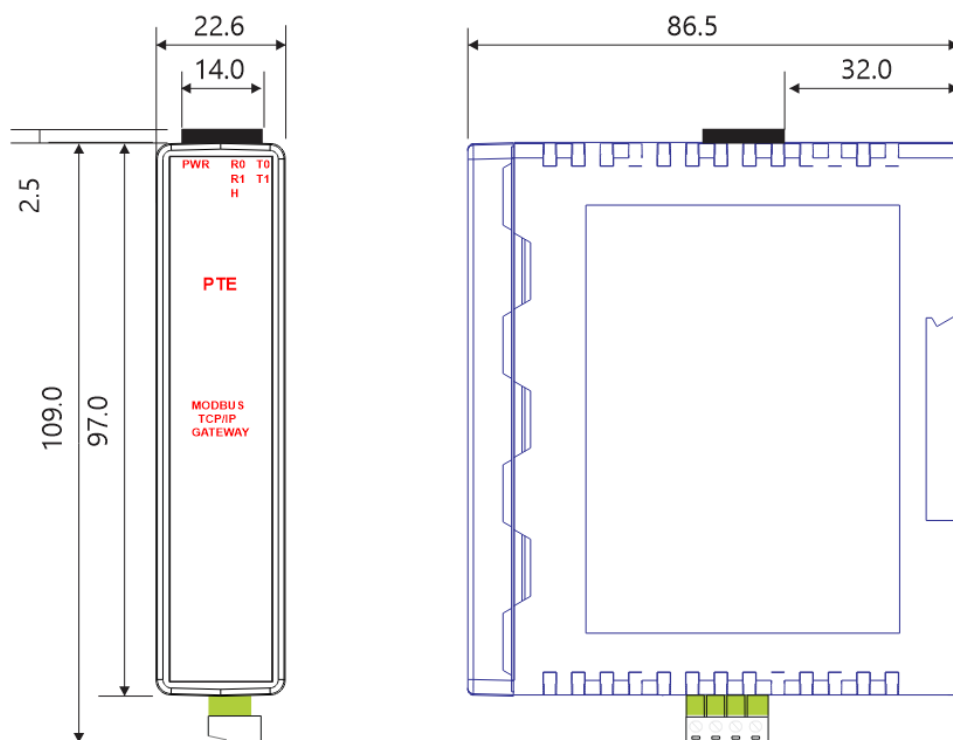

4.1 Grounding/Shielding

In most cases, the gateway will be installed in an enclosure along with other devices which generate electromagnetic radiation. Examples of these devices are relays and contactors, transformers, motor controllers etc. This electromagnetic radiation can induce electrical noise into both power and signal lines, as well as direct radiation into the module causing negative effects on the system. Appropriate grounding, shielding and other protective steps should be taken at the installation stage to prevent these effects. These protective steps include control cabinet grounding, module grounding, cable shield grounding, protective elements for electromagnetic switching devices, correct wiring as well as consideration of cable types and their cross sections.

1. Screened twisted pair cable must be used with the screen grounded at one point only as close to the PTE gateway as possible.

5. Technical Specification

Power Supply	Supply Voltage	12 -24 Vdc
	Supply Current	65mA @ 12V / 34mA @ 24V
Ethernet	10/100 Mbits/s	10/100Base-TX
	Connector	RJ45
	RS485	2 Wire Multidrop twisted pair + GND
	Baud Rate	2400, 4800, 9600, 19200, 38400, 57600, 115200
	Data Bits	5, 6, 7, 8.
	Parity	none, even, odd.
	Stop Bits	1, 2.
Temperature	Operating Temperature.	-20°C to + 75°C
	Storage Temperature	-40°C to + 85°C
Connectors	Power and Comms.	4 Pin Connector on underside of unit
Humidity		Up to 95% non condensing.

6. Configuration

6.1 Power Connections.

The following diagram shows the wiring for the power and RS485 communications.

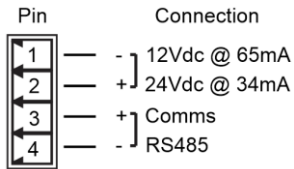

6.2 Ethernet Connection.

Next the Ethernet connection is required, either through a network or directly to a PC. The Ethernet interface uses a standard RJ45 connector.

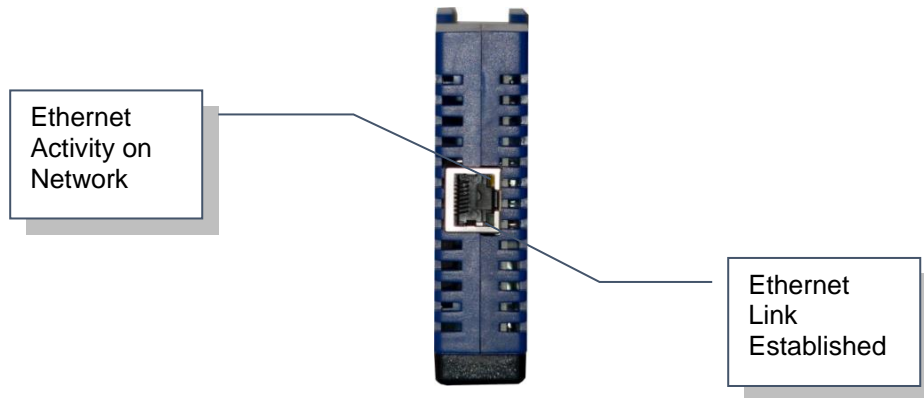

6.3 Indication LED'S.

- Power:** Flashes to indicate the CPU is running.
- Ethernet Rx:** Flashes to indicate the unit has received a valid Modbus message.
- Ethernet Tx:** Flashes to indicate the unit has sent a Modbus message.
- RS485 Rx:** Flashes to indicate the unit has received a valid Modbus message.
- RS485 Tx:** Flashes to indicate the unit has sent a Modbus message.
- HTTP:** Flashes to indicate the unit is accessing a web page.

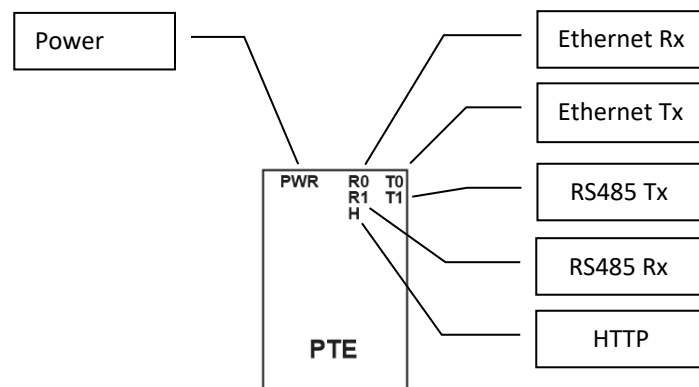

RS485 Termination.

Transmission line effects often present a problem on data communication networks. These problems include reflections and signal attenuation.

To eliminate the presence of reflections from the end of the cable, the cable must be terminated at both ends with a resistor across the line equal to its characteristic impedance. Both ends must be terminated since the direction of propagation is bi-directional. In the case of an RS485 twisted pair cable this termination is typically 120 ohms.

RS485 is designed to be used with a single twisted pair cable. One of the restrictions of this system is that the common mode voltages of the nodes on the network should not exceed -7V or +10V. In order to ensure that this condition is met, it is recommended that the 0V connections on the modules be connected together. For modules that are far apart, a second twisted pair should be used as the 0V link. On the PTE gateway the terminal 1 (GND) is used as the 0V connection.

In certain applications where there are strong possibilities of an earth loop being caused by the 0V link, the link should be tied to the 0V terminal on each module through a 100ohm resistor, to limit the earth loop current.

Where earth loop problems exist, it may be necessary to isolate the RS485 network either using optical fiber or an isolated RS485 repeater such as the PM485REP module.

6.4 Setting the jumpers for the RS485 Termination (J5).

The circuit has got a set of jumpers that can be used to select the termination for the RS485 network. If the jumpers are removed from J5 then no onboard termination will be used and an external termination must be used.

If J5 is setup as shown below, with J5A(1-2) and J5B(2-3) then a 120ohm active termination with **High Line Idle** will be connected to the RS485 network. This is the most commonly used configuration for RS485 networks.

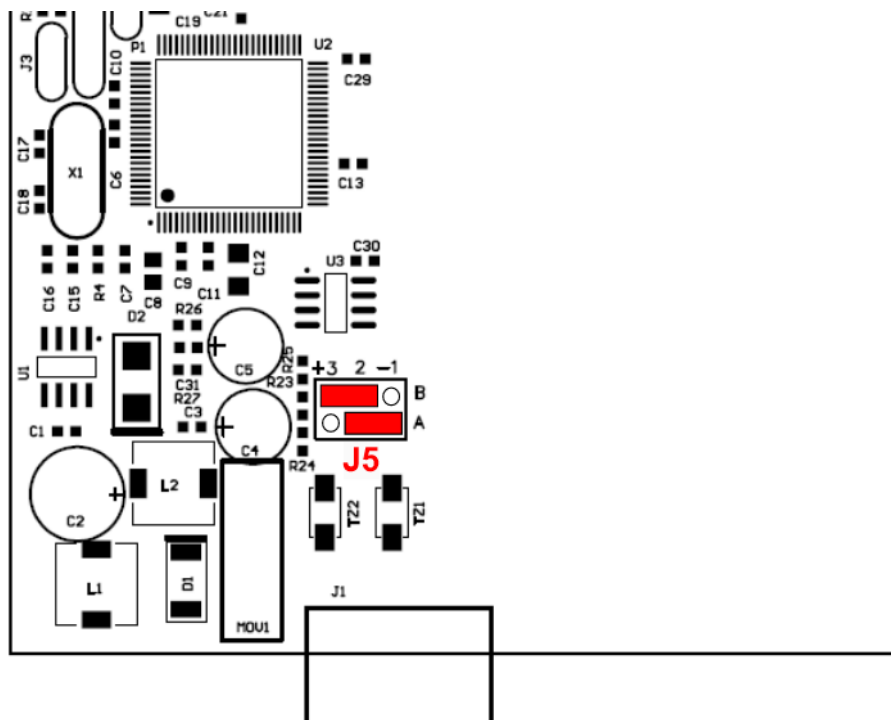

If J5 is setup as shown below, with J5A(2-3) and J5B(1-2) then a 120ohm active termination with **Low Line Idle** will be connected to the RS485 network.

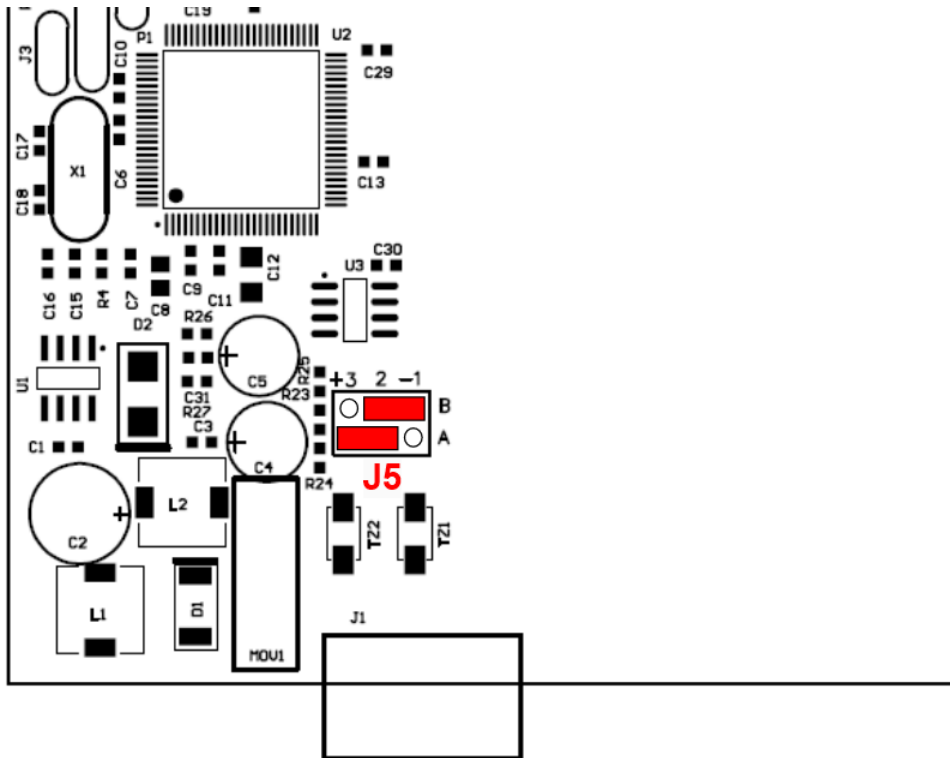

6.5 Connecting To a PC which is not Connected to a Network.

If the PC is equipped with an Ethernet card but not connected to a network, a local network address should be used for communication between the PTE gateway and the PC. The PTE gateway is shipped with a default IP address 169.254.111.111. This address is in the address area reserved for local networks not connected to the Internet. For direct connection between the PC and the PTE gateway, a crossover Ethernet cable is required.



To setup your PC to connect directly to the PTE gateway, an IP address in the same range as the PTE gateway must be assigned to the PC. In Windows environments, this should be done as follows:

- Connect the PC and the PTE gateway together using a crossover cable
- Open the Windows Control Panel
- Select Network
- Select TCP/IP -> the PC's Ethernet adaptor from the Configuration tab as shown below

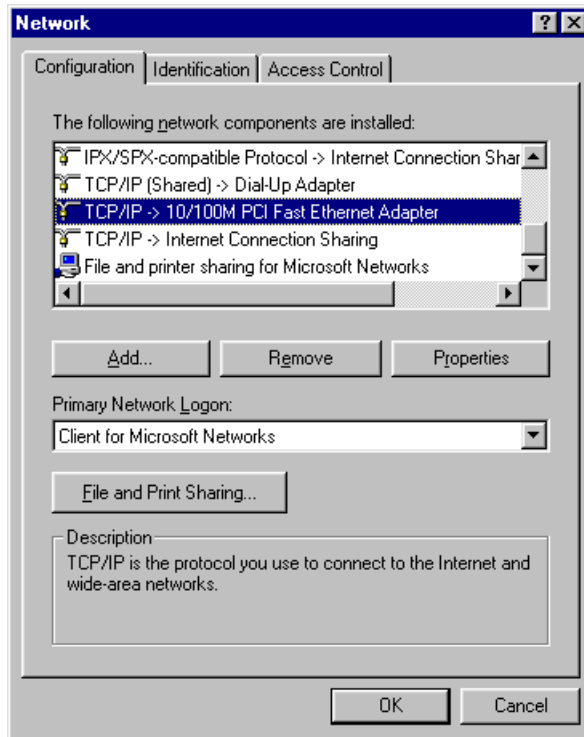

- Click the properties button. A TCP/IP Properties box similar to the one below should appear

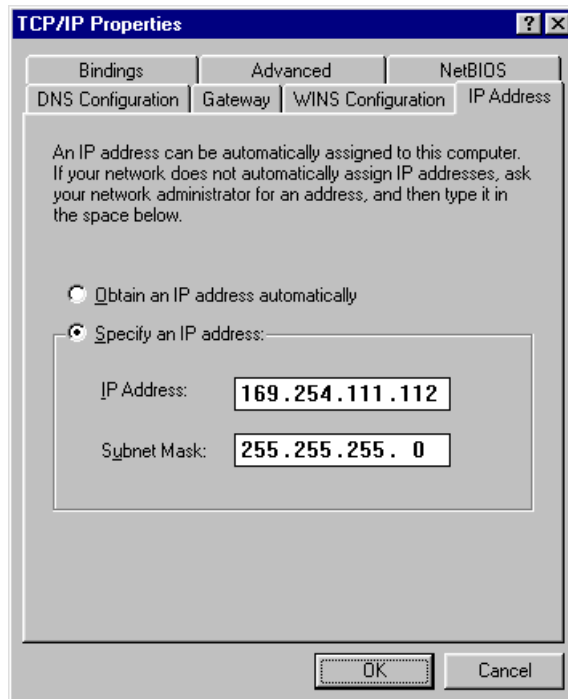

- Select the IP Address tab
- Choose to Specify an IP address as shown in the figure
- Insert the IP address 169.254.111.112 and the corresponding subnet mask as shown
- Save your settings by pressing OK in both TCP/IP properties and Network properties
- Reboot your PC

6.6 Connecting to a PC which is Connected to a Network.

If there is an Ethernet network available, the PTE gateway can be connected to any Ethernet connection or hub belonging to the network. If the PC is connected to a network, there is a strong possibility that the default IP address of the PTE gateway is outside the range of the network (the address doesn't belong to the IP subset of the network). If the Ethernet network is connected to the Internet, this is certain. In this case a new IP address for the PTE gateway is required. Contact the local network administrator to be assigned a free IP address for the PTE gateway. The new IP address is programmed into the PTE gateway using a Web browser software such as Internet explorer. In this case the PTE gateway must first be connected directly to a PC as described above.

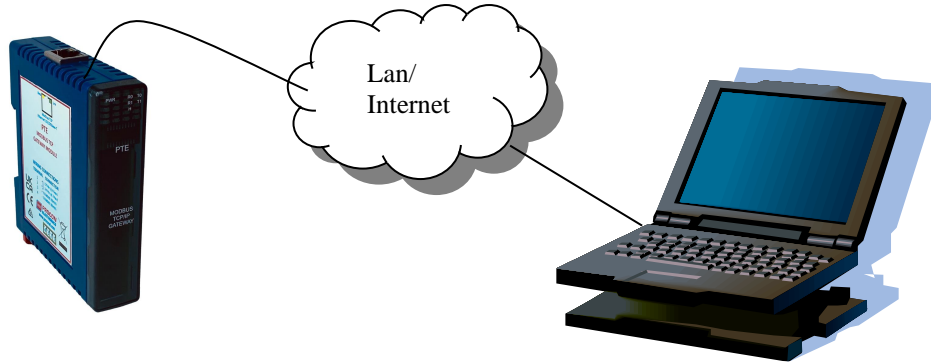

In the remainder of this chapter, the IP address 169.254.111.111 is used as an example. Exchange this IP address with the IP address you have set up in all the occurrences.

6.7 Testing the Connection

To test the connection between the PC and the PTE gateway, a simple program called *ping* can be used. *Ping* sends a number of messages to the specified IP address and displays the response. The ping program can be run from the command line or from a DOS window on the PC, as follows:

- Open the Windows Start Menu
- Click Run
- In the Open box, type: "ping 169.254.111.111"

If the network connection is OK, the program will respond with:
"Reply from 169.254.111.111" and information about the response time.

If there is a problem with the network setup the program will respond:

"Destination host unreachable". There may be two solutions to this problem:

- If the PC is connected in a network, change the IP address to an address accessible from the local network.
- If the PTE gateway is connected directly to the PC(or through a hub), change the PC's IP address to one in the same address range as the PTE Gateway.

If there is a problem with the PTE gateway the program will respond:

"Request timed out", this means that the PTE gateway can not respond to messages. Check the power connection. Check that the Link LED is illuminated when the cable is plugged into the RJ45 connector.

6.8 Viewing Web Pages

The PTE gateway has built in web pages. These are used for checking the configuration and dynamic data, and for altering the configuration. To view these Web pages, a Web browser such as Internet Explorer or Netscape is needed.

To view the default Web page in PTE gateway, start the Web browser and type "169.254.111.111" into the address line of the browser window. The main page of the PTE gateway will now be displayed in the browser window.

If no Web page is displayed, go back to testing the network connection to the PTE gateway by using the ping command. If the PTE gateway replies to the ping messages, check the setup of the Web browser. If the PTE gateway is directly connected to the same network as the PC, "direct connection to the network" or "bypass proxy server for local addresses" should be selected in the Web browser configuration menu. If the PTE gateway is connected to the PC through a firewall, a proxy server should be selected in the configuration menu. Contact the local network administrator for information about the network configuration.

MODBUS TCP / RS485 Converter x

Not secure | 169.254.111.111

PCE PROCON ELECTRONICS

Serial/Ethernet Converter & Modbus Gateway

HOME PAGE

Module Name: PTE

Welcome to the Procon MODBUS TCP Converter home page. This converter is used to connect an Ethernet network to a RS485 network, and converts the Modbus TCP protocol to the standard Modbus RTU serial protocol on RS485.

PTE Configuration Parameters				
Software Version	1			
MAC Address	70b3	d5cb	c000	
Module IP	169	254	111	111
Default Gateway IP	169	254	111	1
Subnet Mask	0	0	0	0
DHCP Enable	0			0=Disable, 1=Enable
Modbus Socket Time Out	90			X 1 second
FTP Socket Time Out	30			X 1 second
Communications Settings				
Baud Rate	9600			
Data Bits	8			
Parity	0			0=None, 1=Even, 2=Odd
Stop Bits	1			

For product information visit the Procon Electronics web site: www.proconel.com

This Web Server is powered by Atmel ARM.

Network Speed 100 Mbits/sec
FULL DUPLEX

6.9 Troubleshooting Guide.

No	Checkpoint		Solution
1	Is the LINK LED on and is the ACTIVITY LED flashing with short pulses?	No	No network connection is detected. The Ethernet cable is either not plugged in or wrong type of cable is used. For connection to a network with a hub or switch, a normal network cable can be used. For direct connection to a PC network card, a twisted cable must be used.
		Yes	A network connection is detected, the PTE gateway is connected to the network.
2	Does the PTE gateway respond to PING requests?	No	<p>Either the PC or the PTE gateway is setup with wrong IP address.</p> <p>To change the IP address of the PTE gateway back to the default address, remove the power, remove the module from the DIN rail, press in the reset switch at the rear of the module using a small screw driver, switch on the power whilst the switch is on and wait 5 seconds, remove the screw driver and switch off the power and replace the module.</p> <p>To change the IP address of a PC, use the Windows "control panel -> network -> TCP/IP properties" and setup an IP address close to the PTE gateway address. The PTE gateway is shipped with a default IP address of 169.254.111.111, the PC can be setup with an IP address of 169.254.111.112</p>
		Yes	The PC and PTE gateway are setup with a correct IP address and they are able to communicate with each other.
3	Can the default Web page be accessed in a Web browser?	No	<p>This is normally caused by the setup of the Web browser.</p> <p>In the "options" or "preferences" menu, check that the Web browser is configured for direct network connection or local area network and NOT using a proxy server.</p>
		Yes	No problems.

6.10 Parameter Configuration

The Web page address "169.254.111.111/ip.htm" is entered into the address line of the browser window to access the configuration page. This page allows you to change the IP address of the PTE gateway, select serial timeout, to setup the baud rate of the PTE gateway on the RS485 network, and to enter a Module Description Name for identification/maintenance purposes.

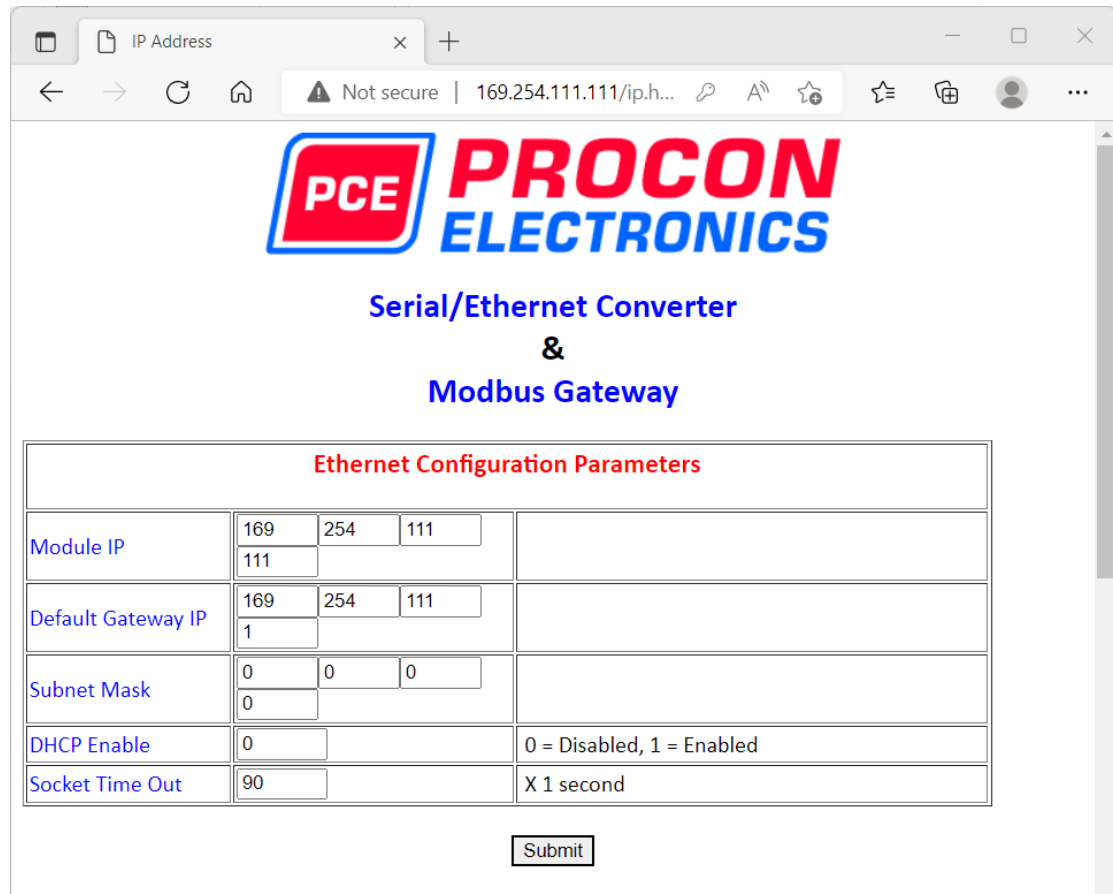

PROCON ELECTRONICS

**Serial/Ethernet Converter
&
Modbus Gateway**

Ethernet Configuration Parameters			
Module IP	169	254	111
	111		
Default Gateway IP	169	254	111
	1		
Subnet Mask	0	0	0
	0		
DHCP Enable	0		0 = Disabled, 1 = Enabled
Socket Time Out	90		X 1 second

- **Module IP Address:** The new IP address can be entered into the web page as shown above. After this has been done, you must click the Submit button to send the values to the PTE gateway. The screen will now be updated and if successful will continue to display the new IP address. The new IP address will only be effective after the PTE gateway power has been switched off and on again. This feature allows you to check that the correct IP address has been entered before being activated. If the IP address has been entered incorrectly and the power has not been switched off, it is possible to re-enter the correct IP address. If the power has been switched off and back on again, the PTE Gateway will not communicate until you enter the new IP address into the address line of the browser window. In the event that the programmed IP address of the module is lost, it is possible to reset the module to the factory IP address.

The following parameters are reset:

- IP address
- Default gateway address
- Subnet mask

The Module can be reset to the factory default by performing the following procedure:

1. Switch off power to the module.
2. Remove the module from the DIN rail.
3. Press in the reset switch at the rear of the module using a small screw driver.
4. Switch on the power whilst the switch is on.
5. Wait 5 seconds.
6. Remove the screw driver and switch off the power.
7. Replace the module.

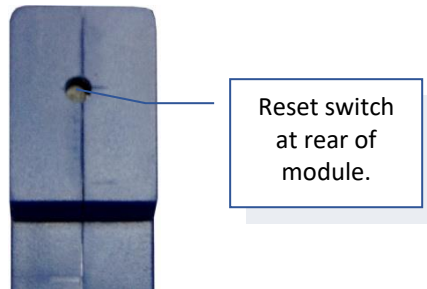

- **Default Gateway IP Address:** A **default gateway** is a node (a router) on a computer network that serves as an access point to another network. In enterprises, however, the gateway is the computer that routes the traffic from a PC to the outside network that is serving the Web pages. It is only necessary to configure the default gateway IP address if the PC that is accessing the gateway is on a different network.
- **Subnet Mask:** In computer networks, a **subnetwork** or **subnet** is a range of logical addresses within the address space that is assigned to an organization. The subnet mask is used to inform the gateway that it must send its replies to the gateway if the IP address of the PC is on a different network. When the subnet mask is set to "0.0.0.0" then it is effectively disabled and the default gateway is not used. A typical subnet mask would be "255.255.255.0".
- **Socket Timeout:** If a socket connection is broken, say due to a network fault, it must timeout to free it up so that it can be used again. This timer is triggered by activity on the gateway, so if there is no communications activity for longer than the timeout period, the socket will close.

Communication Modes		
Converter Mode	<input type="text" value="0"/>	0 = Server - Standard Mode / Multi Socket 1 = Server - Socket Listen Mode / Single socket 2 = Client - Remote Socket Open Mode / Single socket
Char Timeout	<input type="text" value="0"/>	Time to wait before sending Rx Chars when using Port 30004 in Mode 0, or using Mode 1/2 X 10 milliseconds
Port Number	<input type="text" value="0"/>	Modbus TCP = 502 Mode 1&2 only
Server IP	<input type="text" value="0"/> <input type="text" value="0"/> <input type="text" value="0"/> <input type="text" value="0"/>	Mode 2 only
Modbus Comms Watchdog	<input type="text" value="0"/>	X 1 minute

- **Converter Mode:** These modes have been described in detail in a section 2. Enter 0, 1 or 2 as required.
- **Char Timeout:** This timeout has been described in detail in a section 2. Enter a value in 10millisecond increments.
- **Port Number:** The Port number used to tell the gateway that the incoming TCP/UDP message must get sent to the serial port.
- **Server IP:** The client gateway in mode 2 must connect to the server gateway. Enter the IP address of the server gateway in this field.
- **Modbus Communications Watchdog:** If a value other than zero is entered into this field, the watchdog will be enabled and will be reset every time there is a Modbus message. If there is a break in the Modbus message which is longer than the timeout value, then the module will be reset.

RS485 Communications Port Parameters

Baud Rate	9600	
Data Bits	8	
Parity	0	0=None, 1=Even, 2=Odd
Stop Bits	1	
Modbus End of Message Timer	0	X 1 ms + 3.5 Characters
Serial Reply Timeout	30	X 10 milliseconds
RS485 On Delay	0	X 1 milliseconds
RS485 Off Delay	0	X 1 milliseconds

Module Name

Password

Reset Module Use this button to reset the module so that the new configuration will be applied (IP address and/or Comms settings). The reset takes about 5 seconds.

- **Baud Rate, Data Bits, Parity, Stop Bits:** The configuration of the serial port can be configured by selecting the parameters from the pull-down menu. Click on the Submit button to load these values into the PTE Gateway.
- **Modbus End of Message Timer:** The standard way of determining the end of a Modbus message is to time 3.5 characters. (as per the Modbus protocol specification) Some Modbus slaves are not compliant with the Modbus specification and have time delays between characters which would normally result in an error. This field enables the gateway to have a longer end of message timeout to be able to function correctly with these slave devices.
- **Serial Reply Timeout:** This timeout is the time the module waits for a reply from a slave device. If a reply is received then this timeout is cancelled and the gateway looks for the next TCP message. If the slave does not send a reply, then this timeout will expire and allow the gateway to look for the next TCP message. This timeout must be longer than the turn-around time of the slave device or it will timeout before the slave replies. This timeout only operates in Mode 0.
- **RS485 On Delay:** This is the time the RS485 transmitter will be enabled before data is transmitted. This has no effect on RS232 communications.
- **RS485 Off Delay:** This is the time the RS485 transmitter will be enabled after data is transmitted. This has no effect on RS232 communications.

Note: The power must be cycled to reset the unit after the communication settings have been changed.

- **Module Name:** This field allows you to enter a module description name into the PTE gateway. This is an identifier for diagnostic/maintenance purposes and is chosen to best describe the PTE gateway in the system by name or number.
- **Password:** This field allows you to change the password for the module. The modules default password is abc.